

## FLEXISTEM Small Channel Cleaners

Code No	Description	Length (ft.)	Dia. (mm)	Price
FLEX001	Soft Cleaner - Roll	40.0	3.0	\$11.00
FLEX003	Double Clean Stem - 100 each	0.5	3.0	\$32.60
FLEX033	Polypropylene Flexistem - 50 each	1.0	3.0	\$22.00
FLEX004	Fleece Stem - 50 each	1.0	9.0	\$30.00
FLEX006	Bristle Stem - 20 each	1.0	15.0	\$22.00
FLEX007	Bristle Stem - Roll	20.0	15.0	\$19.50
FLEX007A	Wavy Stem - 20Ft Roll (3 mm - 15mm dia.)			\$19.50
FLEX008	Dispenser and 1 pack of each			\$325.50
FLEX009	Complete Refill Pack			\$163.25

## FLEXISTEM Ultra Channel Cleaners

Code No	Description	Length (in.)	Dia. (mm)	Price
FLEX022	Medium Fine - Roll	6.0	6.0	\$18.50
FLEX024	Medium Brush - Roll	6.0	6.0	\$22.00
FLEX025	Dispenser and 1 pack of each			\$216.50
FLEX026	Complete Refill Pack			\$76.00

## ProSys™ Instrument Cleaning Brushes

Code No	Description	Overall Length (cm)	Diameter (mm)	Brush Part (mm)	Qty	Price
CCBRK-1	Complete Brush Kit with Storage Rack				1	\$110.00
RPCBRK-1	Complete Brush Kit w/o Storage Rack				1	\$80.00
4030	Standard Tube Brush	15.80	7.20	53.00	1	\$1.85
4031	Standard Tube Brush	16.00	10.00	52.00	1	\$3.00
520335-12	Standard Tube Brush	20.32	1.40	27.00	12	\$68.00
4032	Standard Tube Brush	21.50	14.30	76.00	1	\$3.00
4033	Standard Tube Brush	21.50	16.00	76.00	1	\$3.00
4034	Standard Tube Brush	21.50	20.00	76.00	1	\$2.25
TR350109-3	Special Tube Brush	30.00	2.30	20.00	3	\$11.00
TR350232-3	Special Tube Brush	30.00	3.00	20.00	3	\$11.00
TR350233-3	Special Tube Brush	30.00	4.00	20.00	3	\$11.00
TR350354-3	Special Tube Brush	30.00	5.00	20.00	3	\$11.00

Code No	Description	Overall Length (cm)	Diameter (mm)	Brush Part (mm)	Qty	Price
TR350429-3	Special Tube Brush	30.00	6.00	20.00	3	\$11.00
520325-12	Standard Tue Brush	30.00	8.00	76.00	12	\$61.00
10-1660	Special Tube Brush	31.00	3.20	57.00	3	\$77.00
520327-12	For 10mm Trocar Sleeves	31.00	10.00	75.00	12	\$58.25
4035	Standard Tube Brush	32.00	25.00	98.00	1	\$3.50
4041-3	Standard Tube Brush	33.00	11.00	89.00	3	\$11.00
4036	Standard Tube Brush	33.00	32.00	102.00	1	\$3.75
4037	Standard Tube Brush	33.00	38.00	102.00	1	\$5.00
4038	Standard Tube Brush	42.50	44.00	130.00	1	\$7.00
4039	Standard Tube Brush	42.50	51.00	125.00	1	\$7.00
10-1664	Special Tube Brush	39.50	9.50	64.00	3	\$93.00
10-1668	Special Tube Brush (8.6mm -29mm Dia)	39.50		89.00	3	\$82.00
ICB-007-6	Cleaning Brush, White Nylon	41.00	4.80	64.00	6	\$58.00
ICB-008-6	Cleaning Brush, White Nylon	41.00	6.30	62.00	6	\$58.00
ICB-013-6	Cleaning Brush, White Nylon	41.00	16.00	65.00	6	\$58.00
ICB-010-6	Cleaning Brush, White Nylon	41.00	12.80	60.00	6	\$58.00
ICB-012-6	Cleaning Brush, White Nylon	41.00	12.50	65.00	6	\$58.00
ICB-014-6	Cleaning Brush, White Nylon	41.00	21.60	63.00	6	\$58.00
ICB-001-6	Cleaning Brush, White Nylon	46.00	1.40	13.00	6	\$58.00
ICB-002-6	Cleaning Brush, White Nylon	46.00	2.50	20.00	6	\$58.00
ICB-003-6	Cleaning Brush, White Nylon	46.00	2.50	24.00	6	\$58.00
ICB-004-6	Cleaning Brush, White Nylon	46.00	2.50	10.00	6	\$58.00
ICB-005-6	Cleaning Brush, White Nylon	46.00	2.80	25.00	6	\$58.00
ICB-006-6	Cleaning Brush, White Nylon	46.00	3.30	53.00	6	\$58.00
520321S-12	Standard Tube Brush	30.00	4.20	74.00	12	\$61.00
520323-12	For 6mm Trocar Sleeves	48.00	6.20	72.00	12	\$61.00
520333-12	Standard Tube Brush	46.00	4.30	78.00	12	\$61.00
TR03020-3	Special Tube Brush	51.00	1.25	13.00	3	\$19.00
130-14	Special Tube Brush	53	7.00	100.00	3	\$18.00
130-38	Special Tube Brush	53	10.70	103.00	3	\$18.00
ICB-009-6	Cleaning Brush, White Nylon	61	6.30	62.00	6	\$58.00
ICB-011-6	Cleaning Brush, White Nylon	61	11.00	65.00	6	\$58.00
4042-3	Standard Tube Brush	61.00	13.00	72.00	3	\$15.00
TR360231-3	Special Tube Brush	61.00	2.50	76.00	3	\$12.00
TR150221-3	Special Tube Brush	61.00	5.00	75.00	3	\$9.00
TR150483-3	Special Tube Brush	61.00	7.00	73.00	3	\$9.00
TR160617-3	Special Tube Brush	61.00	10.00	76.00	3	\$9.00

Prices are subject to change without prior notice

Code No	Description	Overall Length (cm)	Diameter (mm)	Qty	Price
ITB2-30-2	Cleaning Brush	30.00	2.00	30	\$79.00
ITB2-30-4	Cleaning Brush	30.00	4.00	30	\$90.00
ITB2-30-6	Cleaning Brush	35.00	6.20	30	\$39.00
ITB-30-9	Cleaning Brush	35.00	9.00	30	\$41.00
ITB-30-12	Cleaning Brush	35.00	12.00	30	\$82.00
ITB-30-15	Cleaning Brush	35.00	15.00	30	\$74.00
ITB2-60-2	Cleaning Brush	60.00	2.00	30	\$93.00
ITB2-60-4	Cleaning Brush	60.00	4.00	30	\$90.00
ITB2-60-6	Cleaning Brush	65.00	6.20	30	\$45.00
ITB-60-9	Cleaning Brush	65.00	9.00	30	\$57.00
ITB-60-12	Cleaning Brush	65.00	12.00	30	\$82.00
ITB2-60-15	Cleaning Brush	65.00	15.00	30	\$90.00

## Instrument Inspection Tips

Code No	Description	Overall Length (cm)	Diameter (mm)	Qty	Price
ITS-30-110	Inspection Tips	30.00	1.10	30	\$225.00
ITS-30-270	Inspection Tips	30.00	2.70	30	\$103.00
ITS-30-420	Inspection Tips	30.00	4.20	30	\$74.00
ITS-60-110	Inspection Tips	60.00	1.10	30	\$230.00
ITS-60-270	Inspection Tips	60.00	2.70	30	\$134.00
ITS-60-420	Inspection Tips	60.00	4.20	30	\$106.00

## ProSys™ Sterilizer Cleaning Brushes

Code No	Description	Qty	Price
SCBA-01	Sterilizer Cleaning Brush Assortment	3	\$198.62
USB-01	Utility Scrub Brush	1	\$43.71
DB-01	Deck Brush	1	\$58.19
TH-01	Telescoping Handle	1	\$99.96
TB-01	Tank Brush	1	\$67.38
545	Double End Acetabular Reamer Brush	1	82.00

## ProSys™ Instrument Cleaning Brushes

Code No	Description	Overall Length (cm)	Diameter (mm)	Brush Part (mm)	Qty	Price
86-0340-1206	Shaver Brush	15.00	12.70	45.00		\$10.50
86-1234-0006	Shaver Brush	15.00	19.05	57.00		\$9.50
86-0516-1212	Shaver Brush	33.00	8.89	76.00	1	\$8.40
86-00004-0009	Shaver Brush	23.00	7.10	29.00	1	\$10.50
86-021201234	Shaver Brush	15.00	12.70	57.00	1	\$10.50
RB181603	Reamer Brush	46.00	17.00	76.00	1	\$20.00
RB300105	Reamer Brush	76.00	4.00	51.00	1	\$20.00
RB310306	Reamer Brush	87.00	5.68	78.00	1	\$22.00
RB310307	Reamer Brush	87.00	6.70	78.00	1	\$22.00



## Toothbrush Style Brushes

Code No	Description	Length	Width	Trim	QTY	Price
200599-1	Double Ended Brass Brush	18	13.00	13.00	1	\$6.00
200499-1	Double Brush/Stainless	18	13.00	13.00	1	\$8.00
BRS-SB	Double Ended Brush - PKG Sterile	18	13.00	13.00	20	\$150.00
200399-1	Double Brush/Nylon	18	13.00	13.00	1	\$5.25
C1002-3	brass (pack of 3 brushes)	18	38.00	13.00	3	\$21.00
3183-1	nylon	18	11.43	11.43	1	\$2.00
3182-1	stainless	20	38.00	13.00	1	\$3.00
3181-1	nylon	20	38.00	13.00	1	\$3.00
MR001903	nylon	18	12.70	6.35	3	\$58.80

## Block Style Brushes

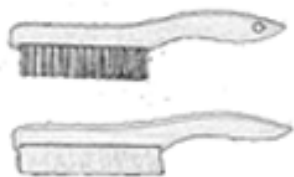

Code No	Description	Length	Width	Trim	Price
869903N	Nylon (Pack of 3)	2.50	3.00	1.25	\$8.00
3090	Stainless	10.00	1.00	1.25	\$10.50
4007	Nylon	10.00	1.00	1.25	\$12.00
GDS1-1	Nylon, w/Surgical Nail Brush	4.00	1.60	0.50	\$2.00
GDS2-1	Nylon	4.10	1.60	0.50	\$2.10

## LTA Instrument Cleaning Brushes

Code No	Description	Overall Length (cm)	Diameter (mm)	Brush Part (mm)	Qty	Price
570	Ext Precision Micro Brush	16.00		32.00	1	\$52.00
540	Acetabular Reamer Brush	17.00		45.00	1	\$52.00
550	Rasp Brush w/Long Rigid Fibers				1	\$87.00
560	Ext Precision Brush w/ Rigid Fibers	17.00		43.00	1	\$52.00
560 CURVE	Acetabular Reamer for Cross Design				1	\$52.00
510	External Brush w/ Rigid Bristles	22.00		76.00	1	\$85.00
510C	Ext Brush w/ Short Rigid Bristles	22.00		76.00	1	\$85.00
520	External Brush w/ Med Bristles	22.00		76.00	1	\$85.00
410	Ext Delicate Brush w/ Rigid Fibers				1	\$98.00
530	Ext Brush w/ Soft Fibers				1	\$87.00
565	Orthopedic Shaver Brush				1	\$94.00
545	Double End Acetabular Reamer				1	\$82.00
610-25-SP	G-Flex Wand & Brush	25.00	4.40	30.00	1	\$94.00
620-25-SP	G-Flex Wand & Brush	25.00	5.40	60.00	1	\$94.00
635-25-SP	G-Flex Wand & Brush	25.00	8.70	58.00	1	\$94.00
655-25-SP	G-Flex Wand & Brush	25.00	14.20	60.00	1	\$94.00
610-50-SP	G-Flex Wand & Brush	50.00	4.40	30.00	1	\$132.00
620-50-SP	G-Flex Wand & Brush	50.00	5.40	60.00	1	\$132.00
635-50-SP	G-Flex Wand & Brush	50.00	8.70	58.00	1	\$132.00
655-50-SP	G-Flex Wand & Brush	50.00	14.20	60.00	1	\$132.00
610-00	3 Pack of Brush Head Refills for 610		4.40	30.00	3	\$51.00
620-00	3 Pack of Brush Head Refills for 620		5.40	60.00	3	\$51.00
635-00	3 Pack of Brush Head Refills for 635		8.70	58.00	3	\$51.00
655-00	3 Pack of Brush Head Refills for 655		14.20	58.00	3	\$51.00
610-SU	Disposable Brush Head for G-Flex 610		4.40	31.50	30	\$148.00
620-SU	Disposable Brush Head for G-Flex 620		5.40	61.50	30	\$148.00
630-SU	Disposable Brush Head for G-Flex 630		6.50	62.00	30	\$148.00
635-SU	Disposable Brush Head for G-Flex 635		8.70	62.00	30	\$148.00
640-SU	Disposable Brush Head for G-Flex 640		10.80	62.50	30	\$148.00
655-SU	Disposable Brush Head for G-Flex 655		14.20	62.50	30	\$148.00

Code No	Description	Overall Length (cm)	Diameter (mm)	Qty	Price
740-30	Microflex	30.00	2.00	1	\$53.00
740-50	Microflex	50.00	2.00	1	\$64.00
750-30	Microflex	30.00	2.65	1	\$53.00
750-50	Microflex	50.00	2.65	1	\$64.00
760-30	Microflex	30.00	3.60	1	\$53.00
760-50	Microflex	50.00	3.60	1	\$64.00
770-30	Microflex	30.00	5.00	1	\$53.00
770-50	Microflex	50.00	5.00	1	\$64.00
780-30	Microflex	30.00	6.00	1	\$53.00
780-50	Microflex	50.00	6.00	1	\$64.00

## Non-Linting Wipes and Sponges

Code No	Description	QTY	Price
NLW002	Non-linting Wipes 12" x 12"	150	\$61.00
NLW003	Non-Linting Wipes Blue 12" x 12"	150	\$61.00
NLW001	Non-Linting Wipes 9"x 9"	200	\$49.00
TX59	Ultra Microdenier Dry Wipes	100	\$170.00
SSW-001	Sterile Wipes 9 x 9 Inches	10	\$57.00
ESD904101	Durasponge, Instrument Sponge, Tubular-Dry	100	\$65.25
ESD905201	Durasponge, Instrument Sponge, Flat-Dry	200	\$65.25

## Pre-rinse Shower Unit

Code No	Description	Price
300718	Deck Mounted Spray Unit	\$1,869.00
300719	Splash Mounted Spray Unit	\$2,034.00
301189	Faucet Add-on with 12" Spout	\$497.00
301190	Wall Bracket	\$128.00
313116	Pre-Rinse Hose 36" Length	\$373.00
313323	Pre-Rinse Spray Valve Assembly	\$320.00

Prices are subject to change without prior notice

## Brush Accessories



Code No	Description	Price
BR001	Brush Storage Rack	\$70.00
BR002	Brush Rack 16Wx 35L Inches	\$227.00
BRS03	Brush Soaking Tray	\$90.00
BSC-01	Brush Sizing Chart	\$21.75
BSK05	Washing Basket for Brushes	\$579.00
110C	LTA Brush Storage Rack	\$100.00



## Flexible Endoscope Brushes

Code No	Description	Dia. (mm)	Length (cm)	Brush length (mm)	QTY	Price
CC2-165-200	Endoscope Brush (1.0 - 1.5mm)	2.0	160	16	12	\$61.00
CC2-100-200	Channel Brush (1.0 - 1.5 mm)	2.0	108	16.0	12	\$49.00
CC2-200-200	Endoscope Brush (1.0 - 1.5 mm)	2.0	210	16.0	12	\$34.00
CC2-230-400	Endoscope Brush (2.2 - 3.2 mm)	4.0	230	27.0	12	\$32.75
CC2-230-600	Endoscope Brush (2.8 - 4.2 mm)	5.5	230	27.0	12	\$32.75
CC2-025-600	Endoscope Brush (2.8 - 4.2 mm)	5.5	25	27.0	12	\$26.25
CC-230-900	Endoscope Brush (5.0 - 7.0 mm)	9.0	230	44.0	12	\$32.75
CC2-200-200-LV11	Endoscope & Valve Brush Kit (1.0 - 1.5mm)	2.0	210	16.0	12	\$56.70
CC2-230-400-LV11	Endoscope & Valve Brush Kit (2.2- 3.2mm)	4.0	230	27.0	12	\$56.75
CC2-230-600-LV11	Endoscope & Valve Brush Kit (2.8 - 4.2mm)	5.5	230	27.0	12	\$56.75
CC-230-900-3770	Endoscope & Valve Brush Kit (5.0 - 7.0mm)	9.0	230	44	12	\$56.75
3770	Trumpet Valve Brush (12mm & 4mm dia/25mm & 9mm Brush)	15.5			1	\$2.50
EMB-002	Elevator Mechanism Brush	3.0	5	10	1	\$1.55

## Spray Guns

Code No	Description	Price
6000	Spray Gun only	\$254.00
6000-6025	Spray Gun with plastic hose & 3/4" connector. Includes 1.5 meter hose (58 inches), 4230 spray tip and wall hook	\$340.00
6020	Spray Gun w/ 1.5 meter hose, 3/4" connector & complete tip set & rack	\$648.00
6000-6045	Spray Gun with plastic hose & 3/4" connector. Includes: 3 meter hose (117 inches), 4230 spray tip and wall hook	\$390.00
5070	Table-top Rosette	\$107.00
80-00-44	Replacement Kit - Flow Control	\$50.50
14RVT	Replacement Hose (Per Foot)	\$3.15
5120	Plumbing 3/4" connector	\$34.00
5110	Plumbing 1/2" connector	\$34.00
4230	Universal Tip	\$35.00
4240	For drainage tube	\$35.00
4250	Spray jet for rinsing out glassware, etc.	\$35.00
5040	Rack Only for Tips	\$89.00
5220	Tip attachments - complete set of all 8 sizes	\$405.00
1HGL4	Hook for spray gun	\$8.40
80-10-12	"O" Rings, 10 per package	\$3.50
4270	For syringes and cannulae with record cone	\$35.00
5010	For measuring and blood pipettes	\$35.00
4260	For syringes and cannulae with Luer cone	\$35.00
5020	For bottles and Erlenmeyer flasks	\$53.00
5030	Water jet pump for suction	\$95.00

## Instrument Protectors

Code No	Description	Qty	Price
IPC001	Instrument Protector, 5.5 x 9.5 Inches	100	\$39.00
IPC002	Instrument Protector, 3.5 x 6.75 Inches	100	\$29.00
IPC003	Instrument Protector, 1.75 x 8.25 Inches	100	\$22.00
IPC004	Robotic Instrument Protector Card	25	\$150.00



Ribbed/Vented  
Tip  
Defenders

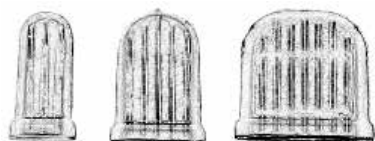

Economical Single-Use  
Tip Protectors

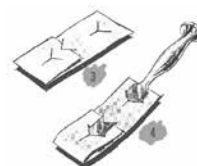

Code No	Dia. (mm)	Height (mm)	Width (mm)	Case	Price
10001	1.6	19.0		100	\$20.00
10002	1.9	19.0		100	\$20.00
10003	2.7	19.0		100	\$20.00
10004	3.2	25.0		100	\$20.00
10005	4.7	25.0		100	\$20.00
10006	10.5	19.0		100	\$20.00
10007	1.6	9.5	25.0	100	\$20.00
10008	1.6	16.0	25.0	100	\$20.00
10009	3.2	25.0	25.0	100	\$20.00
10010	6.3	19.0		100	\$20.00

Code No	Case Qty	Slot Dia. (mm)	Price
PP-001	2000/box, paper	15	\$169.00
PP-002	1000/box, paper	15	\$90.00
PP-003	2000/box, paper	30	\$169.00
PP-004	1000/box, paper	30	\$90.00
PP-005	2000/box, paper	5	\$169.00
PP-006	1000/box, paper	5	\$90.00
PO-007C	200/box, plastic	15	\$34.65
PO-008C	200/box, plastic	30	\$34.65
15.100.055	100/box	32	\$35.70

Vented Instrument Guards



Opaque Code No	Color	Width (mm)	Height (mm)	Dia. (mm)	Case	Price	Clear Code No	Color	Price
09-1-011	White	1.50	19.10		100	\$31.50	09-2-011	Clear	\$31.50
09-1-012	Blue	2.00	19.10		100	\$31.50	09-2-012	Clear	\$31.50
09-1-013	Green	2.80	19.10		100	\$31.50	09-2-013	Clear	\$31.50
09-1-014	Red	3.30	25.40		100	\$31.50	09-2-014	Clear	\$31.50
09-1-015	Yellow	4.80	25.40		100	\$31.50	09-2-015	Clear	\$31.50
09-1-016	Maroon	10.20	19.10		100	\$31.50	09-2-016	Clear	\$31.50
09-1-017	Orange	1.50	9.70	25.40	100	\$31.50	09-2-017	Clear	\$31.50
09-1-018	Brown	2.00	15.90	25.40	100	\$31.50	09-2-018	Clear	\$31.50
09-1-019	Black	3.18	25.40	25.40	100	\$31.50	09-2-019	Clear	\$31.50
09-1-020	Asst. Colors & Sizes				100	\$31.50	09-2-020	Asst. Sizes - Clear	\$31.50

Duo-Vented  
Instrument Guards

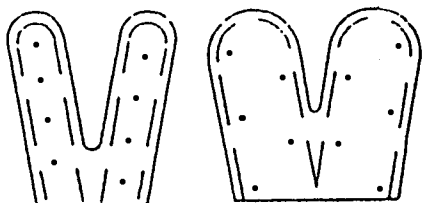

Code No	Color	Height (mm)	Width (mm)	Dia. (mm)	Case	Price
09-3-031	White Tint	1.50	19.10		50	\$34.15
09-3-032	Blue Tint	2.00	19.10		50	\$34.15
09-3-033	Green Tint	2.80	19.10		50	\$34.15
09-3-034	Red Tint	3.30	25.40		50	\$34.15
09-3-035	Yellow Tint	4.80	25.40		50	\$34.15
09-3-037	Orange Tint	1.50	9.70	1.00	50	\$34.15
09-3-040	Assorted sizes/colors				50	\$39.40

Mesh Style Instrument Protectors

Code No	Description	Length	Dia.	QTY	Price
CSW-03-2.0	Mesh Closed End Style Tip Protector	70	6	100	\$33.65
CSW-04-4.0	Mesh Open End Sleeve Tip Protectors	102	13	100	\$23.10

Cylindrical Style Instrument Guards

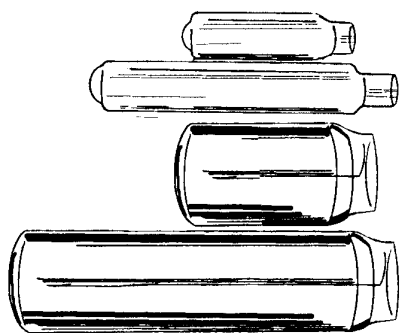

Code No	Description	Length (mm)	Dia. (mm)	Qty	Price
09-7-011	For Veress Needles	20.30	3.00	50	\$21.00
09-7-012	For all 5mm Instruments, trocars, Probes, etc.	30.30	5.00	25	\$18.40
09-7-013	For all 5mm Instruments, trocars, Probes, etc.	43.20	5.00	20	\$17.85
09-7-014	For all 10mm Instruments, trocars, Probes, etc.	20.30	10.00	25	\$18.40
09-7-015	For all 5mm Instruments, trocars, Probes, etc.	57.15	5.00	20	\$17.85

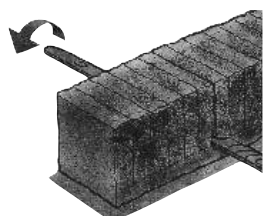

Foam Tray Anchors

Code No	Description	Price
FTA-201	Pack of 16 strips	\$110.00
FTA-204	Pack of 64 strips	\$313.00

## Reticulated Instrument Foam Protection for Steam and EtO

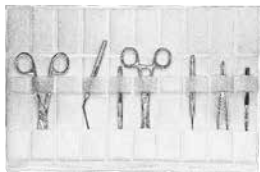

Code No	Description	Width	Length	Case	Price
FP-4800	Precut Sheets	12.00	10.00	50	\$60.00
FP-4880	Precut Sheets	12.00	20.00	25	\$73.00
FP-5200	Pocket w/ Belts	11.00	15.00	10	\$61.00
FP-6200	Rigid Scope Pouch	2.00	20.00	50	\$214.00
FP-6250	Small Single Pouch	2.10	7.50	50	\$49.00
FP-6270	Camera/Fiber-Optic Cable	9.50	10.00	10	\$121.00
FP-1001	Foam Pouch			50	\$112.00
FP-1002	Foam Tip Protector			50	\$38.00
FP-1003	Foam Pinhole Holder			50	\$173.00
FP-1004	Foam Corner Protectors			288	\$225.00
FP-1005	12 Instrument Foam Protector			50	\$275.00
FP-4600	Instrument Foam Protector	30.00	244.00	3	\$110.00

## Plasma-Cel™ Instrument Foam Protection for Plasma Sterilizers

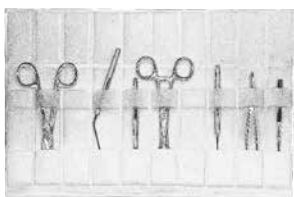

Code No	Description	Width	Length	Case	Price
PC4600	Roll	12.00	72.00	3	\$90.50
PC4800	Precut Sheets	12.00	10.00	50	\$163.00
PC4850	Precut Sheets	12.00	16.00	25	\$126.00
PC4880	Precut Sheets	12.00	20.00	25	\$186.50
PC5200	Pocket w/ Belts	11.00	15.50	10	\$116.50
PC5500	Multi-Pouch	13.00	17.00	10	\$134.00
PC6200	Rigid Scope Pouch	2.00	20.00	50	\$186.50
PC6210	Large Single Pouch	4.00	7.00	50	\$189.00
PC6250	Small Single Pouch	2.10	7.50	50	\$65.50

## Instrument Repair Tags



Code No	Description	Qty	Price
994-G	Green - Good	100	\$26.00
994-R	Red - Repair	100	\$26.00
994-S	Yellow - Sharpen	100	\$26.00

## Latex Scissor Test

Code No	Length	Width	Gauge	Qty	Price
LT-130	5.00	5.00	16	1	\$31.50
RT608	5.50	8.00	8	1	\$19.25
YT606	5.50	6.00	6	1	\$18.00

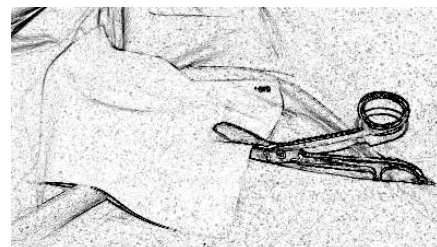

## HotSpot Safe-to-Touch Indicators

Code No	Qty	Price
HS-101	50	\$111.00

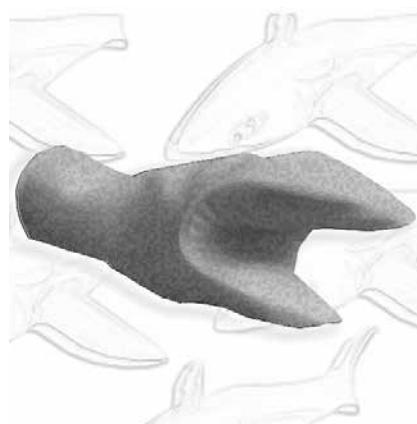

## Insulated Gloves

Code No	Description	Length	Price
75574	Insulated Gauntlet (pair)	17.00	\$15.00
75524	Insulated Gauntlet (pair)	24.00	\$25.00
73224	Insulated Gauntlet (pair)	13.00	\$17.00
JB-2636	Seamless Autoclave Gloves (pair)	12.50	\$26.00
SLG-001	Shark Tooth Heat Mitt (each)	14.00	\$37.00
JB-422-11	Terry Cloth Autoclave Gloves (pair)	11.00	\$24.00

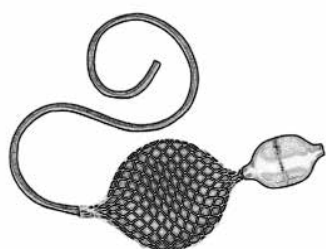

## Disposable Bulb & Bladder

Code No	Description	Qty	Price
D30200-210	CLEAN (non-sterile) Disposable Bulb & Bladder Assembly	4	\$111.00
D30200-210S	STERILE Disposable Bulb & Bladder Assembly	5	\$190.00

## Valve Bags

Code No	Description	Qty	Price
VB604 GN	Valve Bag-Green	100	\$30.00
SVB604 WT CLN	Secure Valve Bag - White - with Clean Lok	100	\$72.00
SVB604 WT	Secure Valve Bag - White - with Num Lok	100	\$72.00

## Pro-Ties™ Bundling System

Code No	Color	Qty	Price
310-054	Yellow	6	\$27.25
310-053	Blue	6	\$27.25
310-052	Green	6	\$27.25
310-051	Red	6	\$27.25



## Silicon Cable & Ties (Also available in a variety of colors)

Code No	Color	Qty	Price
SCIT-01	Clear Cable Ties, 4.3 In. - Cynched	25	\$34.65
SCIT-03	Red Cable Ties, 8.3 In. - Cynched	25	\$40.95
09246	Clear Cable Ties, 2.4 In. - Cynched Wide	25	\$19.95
09373	Clear Cable Ties, 4.3 In. - Cynched Wide	25	\$35.70
SCIT-08	Clear Cable Ties, 7.5 In. - Cynched Wide	25	\$47.25
09139	Green Cable Ties, 19.6 In. - Flat	25	\$18.90

## LBK Weighing Scale

Code No	Description	Price
LBX 30	Weighing Scales	\$398.00

## Clamps & Spreaders

Code No	Description	Price
SSIS-001	Stainless Steel Instrument Spreader	\$32.25
BC-04	Stainless Steel Band Clamp W/Anti-Slide Covering-Green	\$32.25
BC-02	Stainless Steel Band Clamp W/Anti-Slide Covering-Red	\$32.25
BC-01	Stainless Steel Band Clamp W/Anti-Slide Covering-Blue	\$32.25
BC-03	Stainless Steel Band Clamp W/Anti-Slide Covering-Yellow	\$32.25

## EasyStringer™



Code No	Color	Price
ES-100	6" Wide EasyStringer Base	\$81.00
ES-109	9" Wide EasyStringer Base	\$110.00
ES-112	12" Wide EasyStringer Base	\$128.00

## Instrument Stringers

Code No	Description	Width	Rod Diameter	Length	Price
AJS 8	8" long x 2.5" - 5.5" wide				\$106.00
AJS 13	13" long x 2.5" - 5.5" wide				\$113.00
AJS 17	17" long x 2.5" - 5.5" wide				\$115.00
10-1770	Bunt Instrument Holder	1.50		5.25	\$24.00
IWC-001	Stainless Steel Wash Cradle	2.00	3.75	11.50	\$92.00
ST2.64C	Crescent Style	2.50	0.25	6.00	\$46.25
ST2.84C	Crescent Style	2.50	0.25	8.00	\$46.25
ST2.104C	Crescent Style	2.50	0.25	10.00	\$49.00
ST2.124C	Crescent Style	2.50	0.25	12.00	\$50.00
ST2.144C	Crescent Style	2.50	0.25	14.00	\$53.50
ST2.164C	Crescent Style	2.50	0.25	16.00	\$53.50
ST2.184C	Crescent Style	2.50	0.25	18.00	\$79.50
ST3-64C	Crescent Style	3.50	0.25	6.00	\$50.00
ST3-84C	Crescent Style	3.50	0.25	8.00	\$50.00
ST3-104C	Crescent Style	3.50	0.25	10.00	\$50.00
ST3-124C	Crescent Style	3.50	0.25	12.00	\$52.50
ST3-144C	Crescent Style	3.50	0.25	14.00	\$53.50
ST3-164C	Crescent Style	3.50	0.25	16.00	\$60.00
ST3-184C	Crescent Style	3.50	0.25	18.00	\$64.50
ST55-8	Pin Locking Stringer	5.50		8.00	\$62.00
ST-6	Pin Locking Stringer	2.75		6.00	\$50.00
PSIS-8275	EZ Lok Double-Hinge Bar	2.50		8.00	\$84.00
PSIS-10275	EZ Lok Double-Hinge Bar	2.75		10.00	\$91.00
PSIS-12275	EZ Lok Double-Hinge Bar	2.75		12.00	\$114.00
HE8-0014	EZ Lok Double-Hinge Bar	2.50	0.19	14.00	\$91.40
HE8-0016	EZ Lok Double-Hinge Bar	2.50	0.19	16.00	\$100.10
PSIS-6275	Pin & Socket	2.75		6.00	\$80.00
PSIS-8275	Hairpin Style, U-Shaped	2.75		8.00	\$84.00
USPRS-6	Spring Instrument Stringer	2.50	0.25	6.00	\$31.00
USPRS-8	Spring Instrument Stringer	2.50	0.25	8.00	\$33.00
USPRS-10	Spring Instrument Stringer	2.50	0.25	10.00	\$34.00
USPRS-12	Spring Instrument Stringer	2.50	0.25	10.00	\$36.00
USPRS-14	Spring Instrument Stringer	2.50	0.25	14.00	\$38.00

## Instrument Stringers

Code No	Description	Width	Rod Diameter	Length	Price
HE2-0010	Hairpin Style, U-Shaped	2.50	0.19	10.00	\$46.25
HE2-0012	Hairpin Style, U-Shaped	2.50	0.19	12.00	\$50.60
HE2-0014	Hairpin Style, U-Shaped	2.50	0.19	14.00	\$54.50
HE2-0016	Hairpin Style, U-Shaped	2.50	0.19	16.00	\$59.85
HE2-0018	Hairpin Style, U-Shaped	2.50	0.19	18.00	\$65.30
ST-064U	Hairpin Style, U-Shaped	2.50	0.25	6.00	\$32.50
ST-084U	Hairpin Style, U-Shaped	2.50	0.25	8.00	\$32.50
ST-104U	Hairpin Style, U-Shaped	2.50	0.25	10.00	\$32.50
ST-124U	Hairpin Style, U-Shaped	2.50	0.25	12.00	\$36.00
ST-144U	Hairpin Style, U-Shaped	2.50	0.25	14.00	\$38.00
ST-164U	Hairpin Style, U-Shaped	2.50	0.25	16.00	\$40.50
ST-184U	Hairpin Style, U-Shaped	2.50	0.25	18.00	\$44.50
ST3-06U	Hairpin Style, U-Shaped	3.50	0.19	6.00	\$28.50
ST3-08U	Hairpin Style, U-Shaped	3.50	0.19	8.00	\$28.50
ST3-10U	Hairpin Style, U-Shaped	3.50	0.19	10.00	\$28.50
ST3-12U	Hairpin Style, U-Shaped	3.50	0.19	12.00	\$32.50
ST3-14U	Hairpin Style, U-Shaped	3.50	0.19	14.00	\$32.50
ST3-16U	Hairpin Style, U-Shaped	3.50	0.19	16.00	\$32.50
ST3-18U	Hairpin Style, U-Shaped	3.50	0.19	18.00	\$39.50
ST3-064U	Hairpin Style, U-Shaped	3.50	0.25	6.00	\$32.50
ST3-084U	Hairpin Style, U-Shaped	3.50	0.25	8.00	\$32.50
ST3-104U	Hairpin Style, U-Shaped	3.50	0.25	10.00	\$32.50
ST3-124U	Hairpin Style, U-Shaped	3.50	0.25	12.00	\$36.00
ST3-144U	Hairpin Style, U-Shaped	3.50	0.25	14.00	\$38.50
ST3-164U	Hairpin Style, U-Shaped	3.50	0.25	16.00	\$40.50
ST3-184U	Hairpin Style, U-Shaped	3.50	0.25	18.00	\$44.50
ST5-064U	Hairpin Style, U-Shaped	5.00	0.25	6.00	\$35.00
ST5-084U	Hairpin Style, U-Shaped	5.00	0.25	8.00	\$35.00
ST5-104U	Hairpin Style, U-Shaped	5.00	0.25	10.00	\$35.00
ST5-124U	Hairpin Style, U-Shaped	5.00	0.25	12.00	\$39.50
ST5-144U	Hairpin Style, U-Shaped	5.00	0.25	14.00	\$41.50
ST5-164U	Hairpin Style, U-Shaped	5.00	0.25	16.00	\$43.50
ST5-184U	Hairpin Style, U-Shaped	5.00	0.25	18.00	\$49.00
HP6-12U	Hairpin Style, U-Shaped	6.00	0.19	12.00	\$43.50
10-1780	Saunders Instrument Rack	4.00		5.75	\$120.00
HE1-0006-W	Weinstein Instrument Holder	2.50		6.00	\$77.75

## Instrument Stringers

Code No	Description	Width	Length	Price
HE1-0010-W	Weinstein Instrument Holder	2.50	10.00	\$107.10
HE1-0012-W	Weinstein Instrument Holder	2.50	12.00	\$90.60
HE1-0014-W	Weinstein Instrument Holder	2.50	14.00	\$129.00
HE1-0016-W	Weinstein Instrument Holder	2.50	16.00	\$120.75
10-1775	Weisenbach Instrument Forceps		6.00	\$133.00
10-1776	Weisenbach Instrument Forceps		13.50	\$133.00

## Ultrasonic Cleaning Pouch

Code No	Description	Length	Width	Price
8001	Ultrasonic Cleaning Pouch	5.00	8.00	\$78.00
8002	Ultrasonic Cleaning Pouch	8.00	12.00	\$105.00
8003	Ultrasonic Cleaning Pouch	8.00	18.00	\$108.00

## Washer Baskets

Code No	Description	Length	Width	Height	Price
75.0005.4	Wire Basket	9.500	9.875	2.000	\$176.00
75.0005.5	Wire Basket	9.500	9.875	2.750	\$145.00
75.0005.6	Wire Basket	18.875	9.875	2.000	\$237.00
75.0194.4	Wire Basket	18.875	9.875	2.750	\$268.00
75.0005.6	Wire Basket	18.875	9.875	4.000	\$237.00
75.0091.2	Cover	9.500	9.875		\$201.50
75.0194.2	Cover	18.875	9.875		\$240.00
72.1400.5	Large Washer Basket	23.667	15.750	4.000	\$303.00
72.1400.6	Large Washer Basket	23.667	15.750	7.875	\$572.00
NIC000	Round Nic-Nac Basket		3.000	3.000	\$194.00
NNB001	Round Nic-Nac Basket		4.000	1.250	\$163.25
21000-H	Hinged Parts Basket	3.000	1.000	1.000	\$72.45
NNB002	Nic-Nac Basket	7.000	5.000	1.000	\$163.25
NNB003	Nic-Nac Basket	7.000	9.000	1.000	\$185.00
NIC MICRO 1	Round Nic-Nac Basket w/Handle (3/pkg)	1.750			\$21.00
NIC MICRO 2A	Round Nic-Nac Basket (3/pkg)	2.000			\$23.00
NIC MICRO 2	Round Nic-Nac Basket (3/pkg)	2.500			\$22.00
NIC MICRO 3	Round Nic-Nac Basket (3/pkg)	3.000			\$21.75



## Stainless Steel Washing Sleeves

Code No	Description	Qty	Price
SSWS-01	SS Washing Sleeve - 2.16 In (55 mm)	1	\$36.75
SSWS-02	SS Washing Sleeve - 8.66 In (220 mm)	1	\$145.95
SSWS-03	SS Washing Sleeve - 15.16 (385 mm)	1	\$255.15
SSWS-04	SS Washing Sleeve - 19.48 (495 mm)	1	\$328.65

## Medical Grade Paper Bags

Code No	Description	Width	Length	Height	Case	Price
PB1	Paper Bags	3.50	6.00	2.00	1000	\$72.00
PB2	Paper Bags	4.00	7.00	1.00	1000	\$73.00
PB3	Paper Bags	4.70	10.00	2.00	1000	\$100.00
PB4	Paper Bags	5.50	10.00	3.00	1000	\$146.00
PB5	Paper Bags	5.50	13.00	2.00	500	\$76.00
PB7	Paper Bags	7.00	15.00	3.75	500	\$138.00
PB8	Paper Bags	7.50	13.00	2.50	500	\$68.00
PB9	Paper Bags	9.75	15.00	4.00	250	\$79.00
PB10	Paper Bags	11.75	20.75	3.00	250	\$94.50
PBR-15	7 pouches, 1.5" wide	10.00	14.00		500	\$261.00
PBR-35	4 pouches, 3.0" wide	10.00	14.00		100	\$41.00
PBTO	Time Out Bag	5.00	13.00	2.00	500	\$80.00

## Leak Tester Tester/Insulation Tester/Cable Continuity Tester

Code No	Description	Qty	Price
LTT4000	Leak Tester Tester - Set of 4	4	\$1114.00
LTT-1001	Olympus Automated Leak Tester Tester	1	\$221.00
LTT-1002	Handheld Olympus Tester Tester	1	\$339.00
LTT-1003	Handheld Pentax Tester Tester	1	\$276.00
LTT-1004	Handheld Storz Tester Tester	1	\$278.00
MM513-100	Insulation Tester	1	\$3208.00
CCT1000	Cable Continuity Tester Kit	1	\$527.00

## Optical Products

Code No	Color	Price
26106	OptiVisor	\$120.00
26501-DSG	Adjustable Arm Magnifier	\$324.50
26501-B22	Replacement Bulb for 26501-DSG	\$31.50
26505-SIV	WideView Magnifying Lamp	\$237.30
26505-B09	Replacement Bulb for 26505-SIV	\$13.00
EPRO-001SK	Endopro Cam Starter Kit	\$3932.25
MAG-225	LED Interchangeable Magnifier, 2.25" x 36" Reach	\$280.00
MAG-LENS	Set of 3 Interchangeable Lens for MAG-225	\$312.00
MG10081-8	Pocket Microscope	\$22.00
MAG-002	LED 4x Magnifier	\$31.50
MICR008	USB Microscope	\$300.00
FIS-007USK	Flexible Inspection Scope, Control Box & 1.9 mm Catheter	\$7875.00
FIS7-MC	FIS-007 Mobile Cart	\$2009.00
CT-101	1.9 mm, 110 cm length, FIS	\$3307.00
CT-102	1.906mm, 110 cm length, FIS	\$3465.00
CT-103	1.9 mm, 60 cm length, FIS	\$3307.50
FIS-007UB	FIS-007 Control Box Kit & 1.9mm Catheter	\$4567.50
FIS-007HB	FIS-007 HDMI Control Box Kit	\$4935.00
100657-K	Flexarm Kit	\$135.50
CLA-001	Clamp for FIS-007	\$350.00
42400-4 RD	6" Round Red LED Magnifier	\$859.00
82400-4 BL	7" x 5.25" Retangular Blue LED Magnifier	\$1136.00
DB-LM-30	4" DeskBrite LED Magnifier	\$67.00
MAG-310	Hand-held Multi-Magnifier 3x, 10x, 55x	\$10.50
RNDMAG-1	Magic Touch, LED, 3x Magnifier	\$51.50
RNDMAGSTND-1	Stand for RNDMAG-1	\$21.00
LUP-004	Loupe Set with Smartphone Adapter	\$31.50

## Washable Keybopard and Mouse

Code No	Color	Price
KBM-001	Washable Keyboard and Mouse	\$529.20
KB-001	Washable Keyboard	\$321.00
MOS-001	Washable Mouse	\$218.00