

### FLEXIBLE STEM BRUSHES Short Channel Cleaners

Code No	Description	Length (In)	Dia. (mm)	Qty
FL-1203	Soft Clean	12.0	3.0	50
FL-1208	Fleece Stem	12.0	8.0	50
FL-1210	Fleece Stem	12.0	10.0	50
FL-1215	Bristle Stem	12.0	15.0	20

### FLEXIBLE STEM BRUSHES Roll Channel Brushes

Code No	Description	Length (ft)	Dia. (mm)	Qty
FLEX001	Soft Cleaner	32.0	3.0	1
FL-606	Medium Fine	25.0	6.0	1

### FLEXIBLE STEM BRUSHES Accessories

Code No	Description	Qty
FL-US	Utility Scissors	1
FLEX025	Dispenser & Cutter & Pkg - Original	

### ProSys™ Instrument Cleaning Brushes

Code No	Description	Overall Length (cm)	Diameter (mm)	Brush Part (mm)	Qty
CCBRK-1	Complete Brush Kit with Storage Rack				1
RPCBRK-1	Complete Brush Kit w/o Storage Rack				1
ICB-07761-1	Instrument Channel Brush	61.00	7.67	53.00	1
ICB-10041-1	Instrument Channel Brush	41.00	10.00	52.00	1
ICB-01420-12	Instrument Channel Brush	20.32	1.40	27.00	12
ICB-14041-1	Instrument Channel Brush	21.50	14.30	76.00	1
ICB-16021-1	Instrument Channel Brush	21.50	16.00	76.00	1
ICB20041-1	Instrument Channel Brush	21.50	20.00	76.00	1
ICB-02330-3	Instrument Channel Brush	30.00	2.30	20.00	3

Code No	Description	Overall Length (cm)	Diameter (mm)	Brush Part (mm)	Qty
ICB-06030-3	Instrument Channel Brush	30.00	6.00	20.00	3
ICB-08030-12	Standard Tue Brush	30.00	8.00	76.00	12
ICB-0346-3	Instrument Channel Brush	31.00	3.20	57.00	3
ICB-10031-12	Instrument Channel Brush	31.00	10.00	75.00	12
ICB-25032-1	Instrument Channel Brush	32.00	25.00	98.00	1
ICB-11033-3	Instrument Channel Brush	33.00	11.00	89.00	3
ICB-32033-1	Instrument Channel Brush	33.00	32.00	102.00	1
ICB-38033-1	Instrument Channel Brush	33.00	38.00	102.00	1
ICB-44040-1	Instrument Channel Brush	42.50	44.00	130.00	1
ICB-51043-1	Instrument Channel Brush	42.50	51.00	125.00	1
ICB-09540-3	Instrument Channel Brush	39.50	9.50	64.00	3
ICB-30039-3	Instrument Channel Brush	39.50		89.00	3
ICB-04841-6	Instrument Channel Brush	41.00	4.80	64.00	6
ICB-06341-6	Instrument Channel Brush	41.00	6.30	62.00	6
ICB-16041-6	Instrument Channel Brush	41.00	16.00	65.00	6
ICB-12841-6	Instrument Channel Brush	41.00	12.80	60.00	6
ICB-12541-6	Instrument Channel Brush	41.00	12.50	65.00	6
ICB-21641-6	Instrument Channel Brush	41.00	21.60	63.00	6
ICB-01446-6	Instrument Channel Brush	46.00	1.40	13.00	6
ICB-01546-6	Instrument Channel Brush	46.00	1.50	20.00	6
ICB-02046-6	Instrument Channel Brush	46.00	2.00	24.00	6
ICB-02346-6	Instrument Channel Brush	46.00	2.30	10.00	6
ICB-02746-6	Instrument Channel Brush	46.00	2.80	25.00	6
ICB-03346-6	Instrument Channel Brush	46.00	3.30	53.00	6
ICB-04030-3	Instrument Channel Brush	30.00	4.20	74.00	12
ICB-06248-12	Instrument Channel Brush	48.00	6.20	72.00	12
ICB-04046-12	Instrument Channel Brush	46.00	4.00	78.00	12
ICB-01351-3	Instrument Channel Brush	51.00	1.25	13.00	3
ICB-07761-3	Instrument Channel Brush	61	7.67	100.00	3
ICB-10754-3	Instrument Channel Brush	53	10.70	103.00	3
ICB-06361-6	Instrument Channel Brush	61	6.30	62.00	6
ICB-11061-6	Instrument Channel Brush	61	11.00	65.00	6
ICB-13061-3	Instrument Channel Brush	61.00	13.00	72.00	3
ICB-02561-3	Instrument Channel Brush	61.00	2.50	76.00	3
ICB-05030-3	Instrument Channel Brush	61.00	5.00	75.00	3
ICB-07061-3	Instrument Channel Brush	61.00	7.00	73.00	3
ICB-10061-3	Instrument Channel Brush	61.00	10.00	76.00	3

Code No	Description	Overall Length (cm)	Diameter (mm)	Qty
ITB2-30-2	Cleaning Brush	30.00	2.00	30
ITB2-30-4	Cleaning Brush	30.00	4.00	30
ITB2-30-6	Cleaning Brush	35.00	6.20	30
ITB-30-9	Cleaning Brush	35.00	9.00	30
ITB-30-12	Cleaning Brush	35.00	12.00	30
ITB2-30-15	Cleaning Brush	35.00	15.00	30
ITB2-60-2	Cleaning Brush	60.00	2.00	30
ITB2-60-4	Cleaning Brush	60.00	4.00	30
ITB2-60-6	Cleaning Brush	65.00	6.20	30
ITB-60-9	Cleaning Brush	65.00	9.00	30
ITB-60-12	Cleaning Brush	65.00	12.00	30
ITB2-60-15	Cleaning Brush	65.00	15.00	30

### Instrument Inspection Tips

Code No	Description	Overall Length (cm)	Diameter (mm)	Qty
ITS-30-110	Inspection Tips	30.00	1.10	30
ITS-30-270	Inspection Tips	30.00	2.70	30
ITS-30-420	Inspection Tips	30.00	4.20	30
ITS-60-110	Inspection Tips	60.00	1.10	30
ITS-60-270	Inspection Tips	60.00	2.70	30
ITS-60-420	Inspection Tips	60.00	4.20	30

### ProSys™ Sterilizer Cleaning Brushes

Code No	Description	Qty
SCBA-01	Sterilizer Cleaning Brush Assortment	3
USB-01	Utility Scrub Brush	1
DB-01	Deck Brush	1
TH-01	Telescoping Handle	1
TB-01	Tank Brush	1
545	Double End Acetabular Reamer Brush	1

## ProSys™ Instrument Cleaning Brushes

Code No	Description	Overall Length (cm)	Diameter (mm)	Brush Part (mm)	Qty
SHV-12715-1	Shaver Brush– 12.7 mm x 15 cm L	15.00	12.70		1
SHV-19015-1	Shaver Brush– 14-19 mm x 15 cm L	15.00	14-19	55.00	1
SHV-09033-1	Shaver Brush– 9.00 mm x 33 cm L	33.00	9.00	78.00	1
SHV-07341-1	Shaver Brush – 7.33 mm x 41 cm L	41.00	7.33	31.00	1
SHV-13015-1	Shaver Brush – 9-13 mm x 15 cm L	15.00	9-13	56.00	1
RB181603	Reamer Brush	46.00	17.00	76.00	1
RB300105	Reamer Brush	76.00	4.00	51.00	1
RB310306	Reamer Brush	87.00	5.68	78.00	1
RB310307	Reamer Brush	87.00	6.70	78.00	1



## Toothbrush Style Brushes

Code No	Description	Length	Width	Trim	QTY
200599-1	Double Ended Brass Brush	18	13.00	13.00	1
200499-1	Double Brush/Stainless	18	13.00	13.00	1
BRS-SB	Double Ended Brush - PKG Sterile	18	13.00	13.00	20
200399-1	Double Brush/Nylon	18	13.00	13.00	1
C1002-3	brass (pack of 3 brushes)	18	38.00	13.00	3
3183-1	nylon	18	11.43	11.43	1
3182-1	stainless	20	38.00	13.00	1
3181-1	nylon	20	38.00	13.00	1
MR001903	nylon	18	12.70	6.35	3

## Block Style Brushes

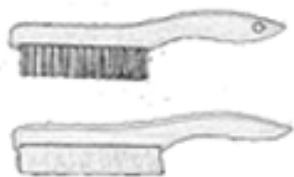

Code No	Description	Length	Width	Trim
869903N	Nylon (Pack of 3)	2.50	3.00	1.25
3090	Stainless	10.00	1.00	1.25
4007	Nylon	10.00	1.00	1.25
GDS1-1	Nylon, w/Surgical Nail Brush	4.00	1.60	0.50
GDS2-1	Nylon	4.10	1.60	0.50

## LTA Instrument Cleaning Brushes

Code No	Description	Overall Length (cm)	Diameter (mm)	Brush Part (mm)	Qty
570	Ext Precision Micro Brush	16.00		32.00	1
540	Acetabular Reamer Brush	17.00		45.00	1
550	Rasp Brush w/Long Rigid Fibers				1
560	Ext Precision Brush w/ Rigid Fibers	17.00		43.00	1
560 CURVE	Acetabular Reamer for Cross Design				1
510	External Brush w/ Rigid Bristles	22.00		76.00	1
510C	Ext Brush w/ Short Rigid Bristles	22.00		76.00	1
520	External Brush w/ Med Bristles	22.00		76.00	1
410	Ext Delicate Brush w/ Rigid Fibers				1
530	Ext Brush w/ Soft Fibers				1
565	Orthopedic Shaver Brush				1
545	Double End Acetabular Reamer				1
610-25-SP	G-Flex Wand & Brush	25.00	4.40	30.00	1
620-25-SP	G-Flex Wand & Brush	25.00	5.40	60.00	1
635-25-SP	G-Flex Wand & Brush	25.00	8.70	58.00	1
655-25-SP	G-Flex Wand & Brush	25.00	14.20	60.00	1
610-50-SP	G-Flex Wand & Brush	50.00	4.40	30.00	1
620-50-SP	G-Flex Wand & Brush	50.00	5.40	60.00	1
635-50-SP	G-Flex Wand & Brush	50.00	8.70	58.00	1
655-50-SP	G-Flex Wand & Brush	50.00	14.20	60.00	1
610-00	3 Pack of Brush Head Refills for 610		4.40	30.00	3
620-00	3 Pack of Brush Head Refills for 620		5.40	60.00	3
635-00	3 Pack of Brush Head Refills for 635		8.70	58.00	3
655-00	3 Pack of Brush Head Refills for 655		14.20	58.00	3
610-SU	Disposable Brush Head for G-Flex 610		4.40	31.50	30
620-SU	Disposable Brush Head for G-Flex 620		5.40	61.50	30
630-SU	Disposable Brush Head for G-Flex 630		6.50	62.00	30
635-SU	Disposable Brush Head for G-Flex 635		8.70	62.00	30
640-SU	Disposable Brush Head for G-Flex 640		10.80	62.50	30
655-SU	Disposable Brush Head for G-Flex 655		14.20	62.50	30

Code No	Description	Overall Length (cm)	Diameter (mm)	Qty
740-30	Microflex	30.00	2.00	1
740-50	Microflex	50.00	2.00	1
750-30	Microflex	30.00	2.65	1
750-50	Microflex	50.00	2.65	1
760-30	Microflex	30.00	3.60	1
760-50	Microflex	50.00	3.60	1
770-30	Microflex	30.00	5.00	1
770-50	Microflex	50.00	5.00	1
780-30	Microflex	30.00	6.00	1
780-50	Microflex	50.00	6.00	1

## Non-Linting Wipes and Sponges

Code No	Description	QTY
NLW002	Non-linting Wipes 12" x 12"	150
NLW003	Non-Linting Wipes Blue 12" x 12"	150
NLW001	Non-Linting Wipes 9"x 9"	200
TX59	Ultra Microdenier Dry Wipes	100
SSW-001	Sterile Wipes 9 x 9 Inches	10
ESD904101	Durasponge, Instrument Sponge, Tubular-Dry	100
ESD905201	Durasponge, Instrument Sponge, Flat-Dry	200

## Pre-rinse Shower Unit

Code No	Description
300718	Deck Mounted Spray Unit
300719	Splash Mounted Spray Unit
301189	Faucet Add-on with 12" Spout
301190	Wall Bracket
313116	Pre-Rinse Hose 36" Length
313323	Pre-Rinse Spray Valve Assembly

## Brush Accessories



Code No	Description
BR001	Brush Storage Rack
BR002	Brush Rack 16Wx 35L Inches
BRS03	Brush Soaking Tray
BSC-01	Brush Sizing Chart
BSK05	Washing Basket for Brushes
110C	LTA Brush Storage Rack



## Flexible Endoscope Brushes

Code No	Description	Dia. (mm)	Length (cm)	Brush length (mm)	QTY
CC2-165-200	Endoscope Brush (1.0 - 1.5mm)	2.0	160	16	12
CC2-100-200	Channel Brush (1.0 - 1.5 mm)	2.0	108	16.0	12
CC2-200-200	Endoscope Brush (1.0 - 1.5 mm)	2.0	210	16.0	12
CC2-230-400	Endoscope Brush (2.2 - 3.2 mm)	4.0	230	27.0	12
CC2-230-600	Endoscope Brush (2.8 - 4.2 mm)	5.5	230	27.0	12
CC2-025-600	Endoscope Brush (2.8 - 4.2 mm)	5.5	25	27.0	12
CC-230-900	Endoscope Brush (5.0 - 7.0 mm)	9.0	230	44.0	12
CC2-200-200-LV11	Endoscope & Valve Brush Kit (1.0 - 1.5mm)	2.0	210	16.0	12
CC2-230-400-LV11	Endoscope & Valve Brush Kit (2.2- 3.2mm)	4.0	230	27.0	12
CC2-230-600-LV11	Endoscope & Valve Brush Kit (2.8 - 4.2mm)	5.5	230	27.0	12
CC-230-900-3770	Endoscope & Valve Brush Kit (5.0 - 7.0mm)	9.0	230	44	12
3770	Trumpet Valve Brush (12mm & 4mm dia/25mm & 9mm Brush)	15.5			1
EMB-002	Elevator Mechanism Brush	3.0	5	10	1

## Spray Guns

Code No	Description
6000	Spray Gun only
6000-6025	Spray Gun with plastic hose & 3/4" connector. Includes 1.5 meter hose (58 inches), 4230 spray tip and wall hook
6020	Spray Gun w/ 1.5 meter hose, 3/4" connector & complete tip set & rack
6000-6045	Spray Gun with plastic hose & 3/4" connector. Includes: 3 meter hose (117 inches), 4230 spray tip and wall hook
5070	Table-top Rosette
80-00-44	Replacement Kit - Flow Control
14RVT	Replacement Hose (Per Foot)
5120	Plumbing 3/4" connector
5110	Plumbing 1/2" connector
4230	Universal Tip
4240	For drainage tube
4250	Spray jet for rinsing out glassware, etc.
5040	Rack Only for Tips
5220	Tip attachments - complete set of all 8 sizes
1HGL4	Hook for spray gun
80-10-12	"O" Rings, 10 per package
4270	For syringes and cannulae with record cone
5010	For measuring and blood pipettes
4260	For syringes and cannulae with Luer cone
5020	For bottles and Erlenmeyer flasks
5030	Water jet pump for suction

## Instrument Protectors

Code No	Description	Qty
IPC001	Instrument Protector, 5.5 x 9.5 Inches	100
IPC002	Instrument Protector, 3.5 x 6.75 Inches	100
IPC003	Instrument Protector, 1.75 x 8.25 Inches	100
IPC004	Robotic Instrument Protector Card	25



Ribbed/Vented  
Tip  
Defenders

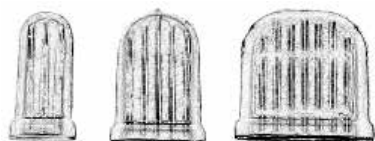

Economical Single-Use  
Tip Protectors

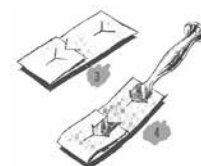

Code No	Dia. (mm)	Height (mm)	Width (mm)	Case
10001	1.6	19.0		100
10002	1.9	19.0		100
10003	2.7	19.0		100
10004	3.2	25.0		100
10005	4.7	25.0		100
10006	10.5	19.0		100
10007	1.6	9.5	25.0	100
10008	1.6	16.0	25.0	100
10009	3.2	25.0	25.0	100
10010	6.3	19.0		100

Code No	Case Qty	Slot Dia. (mm)
PP-001	2000/box, paper	15
PP-002	1000/box, paper	15
PP-003	2000/box, paper	30
PP-004	1000/box, paper	30
PP-005	2000/box, paper	5
PP-006	1000/box, paper	5
PO-007C	200/box, plastic	15
PO-008C	200/box, plastic	30
PPT-DV-01	100/box, paper	15
PPT-DV-02	100/box, paper	30
15.100.055	100/box	32

Vented Instrument Guards

Opaque Code No	Color	Width (mm)	Height (mm)	Dia. (mm)	Case	Price	Clear Code No	Color
09-1-011	White	1.50	19.10		100	\$31.50	09-2-011	Translucent Blue
09-1-012	Blue	2.00	19.10		100	\$31.50	09-2-012	Translucent Blue
09-1-013	Green	2.80	19.10		100	\$31.50	09-2-013	Translucent Blue
09-1-014	Red	3.30	25.40		100	\$31.50	09-2-014	Translucent Blue
09-1-015	Yellow	4.80	25.40		100	\$31.50	09-2-015	Translucent Blue
09-1-016	Maroon	10.20	19.10		100	\$31.50	09-2-016	Translucent Blue
09-1-017	Orange	1.50	9.70	25.40	100	\$31.50	09-2-017	Translucent Blue
09-1-018	Brown	2.00	15.90	25.40	100	\$31.50	09-2-018	Translucent Blue
09-1-019	Black	3.18	25.40	25.40	100	\$31.50	09-2-019	Translucent Blue
09-1-020	Asst. Colors & Sizes				100	\$31.50	09-2-020	Asst. Sizes - Translucent Blue

### Duo-Vented Instrument Guards

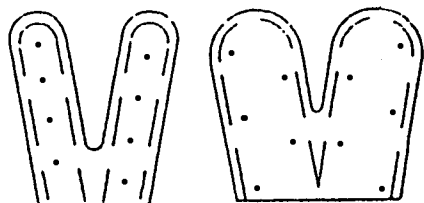

Code No	Color	Height (mm)	Width (mm)	Dia. (mm)	Case
09-3-031	White Tint	1.50	19.10		50
09-3-032	Blue Tint	2.00	19.10		50
09-3-033	Green Tint	2.80	19.10		50
09-3-034	Red Tint	3.30	25.40		50
09-3-035	Yellow Tint	4.80	25.40		50
09-3-037	Orange Tint	1.50	9.70	1.00	50
09-3-040	Assorted sizes/ colors				50

### Mesh Style Instrument Protectors

Code No	Description	Length	Dia.	QTY
CSW-03-2.0	Mesh Closed End Style Tip Protector	70	6	100
CSW-04-4.0	Mesh Open End Sleeve Tip Protectors	102	13	100

### Cylindrical Style Instrument Guards

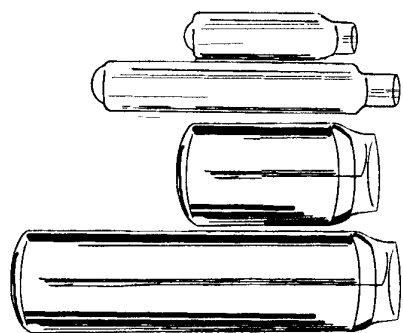

Code No	Description	Length (mm)	Dia. (mm)	Qty
09-7-011	For Veress Needles	20.30	3.00	50
09-7-012	For all 5mm Instruments, trocars, Probes, etc.	30.30	5.00	25
09-7-013	For all 5mm Instruments, trocars, Probes, etc.	43.20	5.00	20
09-7-014	For all 10mm Instruments, trocars, Probes, etc.	20.30	10.00	25
09-7-015	For all 5mm Instruments, trocars, Probes, etc.	57.15	5.00	20

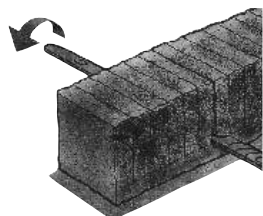

### Foam Tray Anchors

Code No	Description
FTA-201	Pack of 16 strips
FTA-204	Pack of 64 strips

### Reticulated Instrument Foam Protection for Steam and EtO

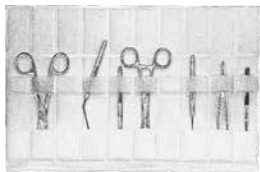

Code No	Description	Width	Length	Case
FP-4800	Precut Sheets	12.00	10.00	50
FP-4880	Precut Sheets	12.00	20.00	25
FP-5200	Pocket w/ Belts	11.00	15.00	10
FP-6200	Rigid Scope Pouch	2.00	20.00	50
FP-6250	Small Single Pouch	2.10	7.50	50
FP-6270	Camera/Fiber-Optic Cable	9.50	10.00	10
FP-1001	Foam Pouch			50
FP-1002	Foam Tip Protector			50
FP-1003	Foam Pinhole Holder			50
FP-1004	Foam Corner Protectors			288
FP-1005	12 Instrument Foam Protector			50
FP-4600	Instrument Foam Protector	30.00	244.00	3

### Plasma-Cel™ Instrument Foam Protection for Plasma Sterilizers

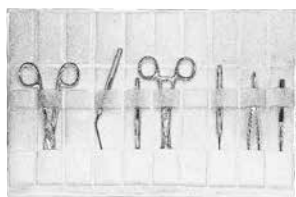

Code No	Description	Width	Length	Case
PC4600	Roll	12.00	72.00	3
PC4800	Precut Sheets	12.00	10.00	50
PC4850	Precut Sheets	12.00	16.00	25
PC4880	Precut Sheets	12.00	20.00	25
PC5200	Pocket w/ Belts	11.00	15.50	10
PC5500	Multi-Pouch	13.00	17.00	10
PC6200	Rigid Scope Pouch	2.00	20.00	50
PC6210	Large Single Pouch	4.00	7.00	50
PC6250	Small Single Pouch	2.10	7.50	50

### Instrument Repair Tags



Code No	Description	Qty
994-G	Green - Good	100
994-R	Red - Repair	100
994-S	Yellow - Sharpen	100

### Latex Scissor Test

Code No	Length	Width	Gauge	Qty
LT-130	5.00	5.00	16	1
RT608	5.50	8.00	8	1
YT606	5.50	6.00	6	1

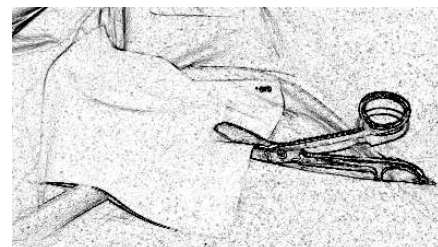

### HotSpot Safe-to-Touch Indicators

Code No	Qty
HS-101	50

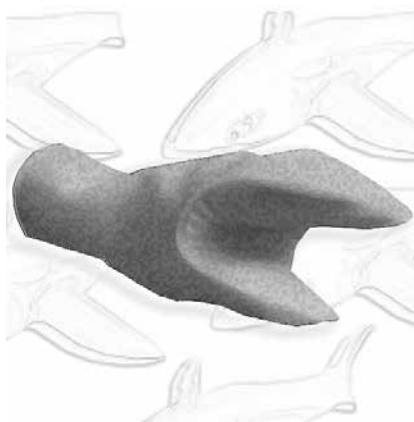

### Insulated Gloves

Code No	Description	Length
75574	Insulated Gauntlet (pair)	17.00
75524	Insulated Gauntlet (pair)	24.00
73224	Insulated Gauntlet (pair)	13.00
JB-2636	Seamless Autoclave Gloves (pair)	12.50
SLG-001	Shark Tooth Heat Mitt (each)	14.00
JB-422-11	Terry Cloth Autoclave Gloves (pair)	11.00

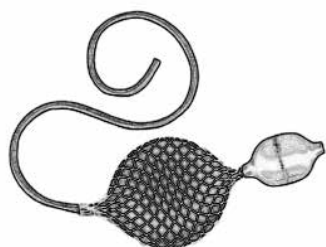

### Disposable Bulb & Bladder

Code No	Description	Qty
D30200-210	CLEAN (non-sterile) Disposable Bulb & Bladder Assembly	4
SBB-01-5	STERILE Disposable Bulb & Bladder Assembly	5

### Valve Bags

Code No	Description
VB604 GN	Valve Bag-Green
SVB604 WT CLN	Secure Valve Bag - White - with Clean Lok
SVB604 WT	Secure Valve Bag - White - with Num Lok

## Pro-Ties™ Bundling System

Code No	Color	Qty
310-054	Yellow	6
310-053	Blue	6
310-052	Green	6
310-051	Red	6



## Silicon Cable & Ties (Also available in a variety of colors)

Code No	Color	Qty
SCIT-01	Clear Cable Ties, 4.3 In. - Cynched	25
SCIT-03	Red Cable Ties, 8.3 In. - Cynched	25
09246	Clear Cable Ties, 2.4 In. - Cynched Wide	25
SCIT-08	Clear Cable Ties, 7.5 In. - Cynched Wide	25
09139	Green Cable Ties, 19.6 In. - Flat	25

## LBK Weighing Scale

Code No	Description
LBX 30	Weighing Scales

## Clamps & Spreaders

Code No	Description
SSIS-001	Stainless Steel Instrument Spreader
BC-04	Stainless Steel Band Clamp W/Anti-Slide Covering-Green
BC-02	Stainless Steel Band Clamp W/Anti-Slide Covering-Red
BC-01	Stainless Steel Band Clamp W/Anti-Slide Covering-Blue
BC-03	Stainless Steel Band Clamp W/Anti-Slide Covering-Yellow

## EasyStringer™



Code No	Color
ES-100	6" Wide EasyStringer Base
ES-109	9" Wide EasyStringer Base
ES-112	12" Wide EasyStringer Base

## Instrument Stringers

Code No	Description	Width	Rod Diameter	Length
AJS 8	8" long x 2.5" - 5.5" wide			
AJS 13	13" long x 2.5"- 5.5" wide			
AJS 17	17" long x 2.5" -5.5 wide			
10-1770	Bunt Instrument Holder	1.50		5.25
IWC-001	Stainless Steel Wash Cradle	2.00	3.75	11.50
ST2.64C	Crescent Style	2.50	0.25	6.00
ST2.84C	Crescent Style	2.50	0.25	8.00
ST2.104C	Crescent Style	2.50	0.25	10.00
ST2.124C	Crescent Style	2.50	0.25	12.00
ST2.144C	Crescent Style	2.50	0.25	14.00
ST2.164C	Crescent Style	2.50	0.25	16.00
ST3-64C	Crescent Style	3.50	0.25	6.00
ST3-84C	Crescent Style	3.50	0.25	8.00
ST3-104C	Crescent Style	3.50	0.25	10.00
ST3-124C	Crescent Style	3.50	0.25	12.00
ST3-144C	Crescent Style	3.50	0.25	14.00
ST3-164C	Crescent Style	3.50	0.25	16.00
ST3-184C	Crescent Style	3.50	0.25	18.00
ST55-8	Pin Locking Stringer	5.50		8.00
ST-6	Pin Locking Stringer	2.75		6.00
PSIS-8275	EZ Lok Double-Hinge Bar	2.50		8.00
PSIS-10275	EZ Lok Double-Hinge Bar	2.75		10.00
PSIS-12275	EZ Lok Double-Hinge Bar	2.75		12.00
HE8-0016	EZ Lok Double-Hinge Bar	2.50	0.19	16.00
PSIS-6275	Pin & Socket	2.75		6.00
PSIS-8275	Hairpin Style, U-Shaped	2.75		8.00
USPRS-6	Spring Instrument Stringer	2.50	0.25	6.00
USPRS-8	Spring Instrument Stringer	2.50	0.25	8.00
USPRS-10	Spring Instrument Stringer	2.50	0.25	10.00
USPRS-12	Spring Instrument Stringer	2.50	0.25	10.00
USPRS-14	Spring Instrument Stringer	2.50	0.25	14.00

## Instrument Stringers

Code No	Description	Width	Rod Diameter	Length
HE2-0010	Hairpin Style, U-Shaped	2.50	0.19	10.00
HE2-0012	Hairpin Style, U-Shaped	2.50	0.19	12.00
HE2-0014	Hairpin Style, U-Shaped	2.50	0.19	14.00
HE2-0016	Hairpin Style, U-Shaped	2.50	0.19	16.00
HE2-0018	Hairpin Style, U-Shaped	2.50	0.19	18.00
ST-064U	Hairpin Style, U-Shaped	2.50	0.25	6.00
ST-084U	Hairpin Style, U-Shaped	2.50	0.25	8.00
ST-104U	Hairpin Style, U-Shaped	2.50	0.25	10.00
ST-124U	Hairpin Style, U-Shaped	2.50	0.25	12.00
ST-144U	Hairpin Style, U-Shaped	2.50	0.25	14.00
ST-164U	Hairpin Style, U-Shaped	2.50	0.25	16.00
ST-184U	Hairpin Style, U-Shaped	2.50	0.25	18.00
ST3-06U	Hairpin Style, U-Shaped	3.50	0.19	6.00
ST3-08U	Hairpin Style, U-Shaped	3.50	0.19	8.00
ST3-10U	Hairpin Style, U-Shaped	3.50	0.19	10.00
ST3-12U	Hairpin Style, U-Shaped	3.50	0.19	12.00
ST3-16U	Hairpin Style, U-Shaped	3.50	0.19	16.00
ST3-18U	Hairpin Style, U-Shaped	3.50	0.19	18.00
ST3-064U	Hairpin Style, U-Shaped	3.50	0.25	6.00
ST3-084U	Hairpin Style, U-Shaped	3.50	0.25	8.00
ST3-104U	Hairpin Style, U-Shaped	3.50	0.25	10.00
ST3-124U	Hairpin Style, U-Shaped	3.50	0.25	12.00
ST3-144U	Hairpin Style, U-Shaped	3.50	0.25	14.00
ST3-164U	Hairpin Style, U-Shaped	3.50	0.25	16.00
ST3-184U	Hairpin Style, U-Shaped	3.50	0.25	18.00
ST5-064U	Hairpin Style, U-Shaped	5.00	0.25	6.00
ST5-084U	Hairpin Style, U-Shaped	5.00	0.25	8.00
ST5-104U	Hairpin Style, U-Shaped	5.00	0.25	10.00
ST5-124U	Hairpin Style, U-Shaped	5.00	0.25	12.00
ST5-144U	Hairpin Style, U-Shaped	5.00	0.25	14.00
ST5-164U	Hairpin Style, U-Shaped	5.00	0.25	16.00
ST5-184U	Hairpin Style, U-Shaped	5.00	0.25	18.00
HP6-12U	Hairpin Style, U-Shaped	6.00	0.19	12.00
10-1780	Saunders Instrument Rack	4.00		5.75

### Instrument Stringers

Code No	Description	Width	Length
10-1775	Weisenbach Instrument Forceps		6.00
10-1776	Weisenbach Instrument Forceps		13.50

### Ultrasonic Cleaning Pouch

Code No	Description	Length	Width
8001	Ultrasonic Cleaning Pouch	5.00	8.00
8002	Ultrasonic Cleaning Pouch	8.00	12.00
8003	Ultrasonic Cleaning Pouch	8.00	18.00

### Washer Baskets

Code No	Description	Length	Width	Height
75.0005.4	Wire Basket	9.500	9.875	2.000
75.0005.5	Wire Basket	9.500	9.875	2.750
75.0005.6	Wire Basket	18.875	9.875	2.000
75.0194.4	Wire Basket	18.875	9.875	2.750
75.0005.6	Wire Basket	18.875	9.875	4.000
75.0091.2	Cover	9.500	9.875	
75.0194.2	Cover	18.875	9.875	
72.1400.5	Large Washer Basket	23.667	15.750	4.000
72.1400.6	Large Washer Basket	23.667	15.750	7.875
NIC000	Round Nic-Nac Basket		3.000	3.000
NNB001	Round Nic-Nac Basket		4.000	1.250
21000-H	Hinged Parts Basket	3.000	1.000	1.000
NNB002	Nic-Nac Basket	7.000	5.000	1.000
NNB003	Nic-Nac Basket	7.000	9.000	1.000
NIC MICRO 1	Round Nic-Nac Basket w/Handle (3/pkg)	1.750		
NIC MICRO 2A	Round Nic-Nac Basket (3/pkg)	2.000		
NIC MICRO 2	Round Nic-Nac Basket (3/pkg)	2.500		
NIC MICRO 3	Round Nic-Nac Basket (3/pkg)	3.000		



## Stainless Steel Washing Sleeves

Code No	Description	Qty
SSWS-01	SS Washing Sleeve - 2.16 In (55 mm)	1
SSWS-02	SS Washing Sleeve - 8.66 In (220 mm)	1
SSWS-03	SS Washing Sleeve - 15.16 (385 mm)	1
SSWS-04	SS Washing Sleeve - 19.48 (495 mm)	1

## Medical Grade Paper Bags

Code No	Description	Width	Length	Height	Case
PB1	Paper Bags	3.50	6.00	2.00	1000
PB2	Paper Bags	4.00	7.00	1.00	1000
PB3	Paper Bags	4.70	10.00	2.00	1000
PB4	Paper Bags	5.50	10.00	3.00	1000
PB5	Paper Bags	5.50	13.00	2.00	500
PB7	Paper Bags	7.00	15.00	3.75	500
PB8	Paper Bags	7.50	13.00	2.50	500
PB9	Paper Bags	9.75	15.00	4.00	250
PB10	Paper Bags	11.75	20.75	3.00	250
PBR-15	7 pouches, 1.5" wide	10.00	14.00		500
PBR-35	4 pouches, 3.0" wide	10.00	14.00		100
PBTO	Time Out Bag	5.00	13.00	2.00	500

## Leak Tester Tester/Insulation Tester/Cable Continuity Tester

Code No	Description	Qty
LTT4000	Leak Tester Tester - Set of 4	4
LTT-1001	Olympus Automated Leak Tester Tester	1
LTT-1002	Handheld Olympus Tester Tester	1
LTT-1003	Handheld Pentax Tester Tester	1
LTT-1004	Handheld Storz Tester Tester	1
MM513-100	Insulation Tester	1
CCT1000	Cable Continuity Tester Kit	1

## Optical Products

Code No	Color
26106	OptiVisor
26501-DSG	Adjustable Arm Magnifier
26501-B22	Replacement Bulb for 26501-DSG
26505-SIV	WideView Magnifying Lamp
26505-B09	Replacement Bulb for 26505-SIV
EPRO-001SK	Endopro Cam Starter Kit
MAG-225	LED Interchangeable Magnifier, 2.25" x 36" Reach
MAG-LENS	Set of 3 Interchangeable Lens for MAG-225
MG10081-8	Pocket Microscope
MAG-002	LED 4x Magnifier
MICR008	USB Microscope
FIS-007USK	Flexible Inspection Scope, USB Control Box Kit
FIS7-MC	FIS-007 Mobile Cart
CT-101	1.9 mm, 110 cm length, FIS
CT-102	1.06 mm, 110 cm length, FIS
CT-103	1.9 mm, 60 cm length, FIS
FIS-007UB	FIS-007 Control Box Kit & 1.9mm Catheter
FIS-007HB	FIS-007 HDMI Control Box Kit
100657-K	Flexarm Kit
CLA-001	Clamp for FIS-007
42400-4 RD	6" Round Red LED Magnifier
82400-4 BL	7" x 5.25" Retangular Blue LED Magnifier
DB-LM-30	4" DeskBrite LED Magnifier
MAG-310	Hand-held Multi-Magnifier 3x,10x,55x
RNDMAG-1	Magic Touch, LED, 3x Magnifier
RNDMAGSTND-1	Stand for RNDMAG-1
LUP-004	Loupe Set with Smartphone Adapter

## Washable Keyboard and Mouse

Code No	Color
KBM-001	Washable Keyboard and Mouse
KB-001	Washable Keyboard
MOS-001	Washable Mouse